

COLAMY

USER MANUAL

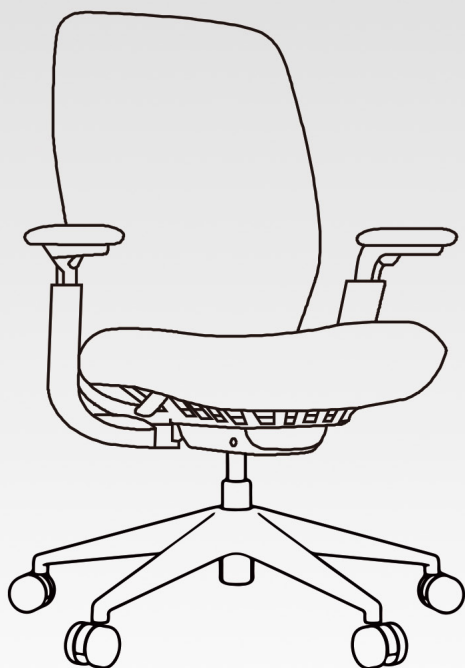

OCM03

OFFICE CHAIR

CONTENTS

01	WARNING	01
02	SAFETY INFORMATION	01
03	ASSEMBLY PARTS AND TOOL	02
04	ASSEMBLY INSTRUCTIONS	03
05	ADJUSTMENT INSTRUCTIONS	07
06	LIMITED WARRANTY	11

WARNING

Please read the instructions carefully and follow the assembly steps.

To ensure proper assembly, please follow all steps and use all parts provided. Not following this warning may result in serious injury to you or others.

To prevent misalignments, keep the screws loose and do not tighten them until they are all in their correct positions.







Avoid overtightening or forcing the screws, as this could cause them to break, strip, or damage the threads of the holes.

Using the wrong size of screws for a particular part could cause damage to the screw or the part.

Please lubricate all moving parts regularly and tighten all bolts and screws every 6 months, or as needed.

SAFETY INFORMATION





WEIGHT CAPACITY FOR PRODUCT: 300 LBS (≈136 KG)

 <p>Sit in the center of the chair with your back against the backrest</p>	 <p>Do not sit at the front edge of the chair</p>	 <p>Do not stand on the chair</p>	 <p>Do not use the chair with more than one person</p>
	 <p>Do not push the chair around when a person is sitting in it</p>	 <p>Do not push down on the backrest when a person is reclined</p>	 <p>Do not place all your weight on the backrest only</p>

ASSEMBLY PARTS AND TOOL

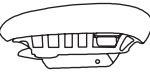
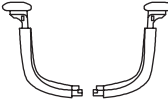
PLEASE MAKE SURE ALL THE PARTS ARE INCLUDED.

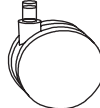
MISSING PARTS?
support@colamyhome.com

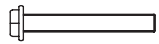
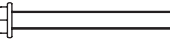
 <p>Backrest *1</p>	 <p>Seat Cushion *1</p>	 <p>Armrests *2</p>	 <p>Gas Lift *1</p>
 <p>Star Base *1</p>	 <p>Casters *5</p>	 <p>Allen Key *1</p>	 <p>M8x25 Bolt *3</p>
 <p>M8x55 Bolt *2</p>	 <p>M8x95 Bolt *2</p>		

BEFORE YOU GET STARTED, A FEW POINTERS:

 Having a friend to help makes assembly extra-easy.

 Please use the included wrench instead of an ELECTRIC HAND DRILL to avoid damage to the product.

ASSEMBLY INSTRUCTIONS

- STEP 1** Turn the Star Base (E) upside down, then press the Casters (F) into the holes at the end of each base leg.

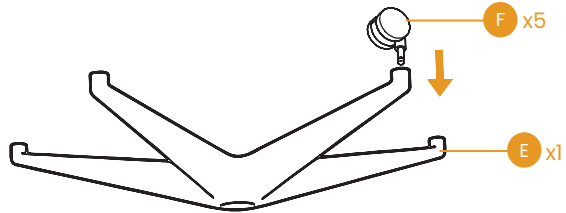

- STEP 2** Insert the Gas Lift (D) into the center hole of the Star Base (E).

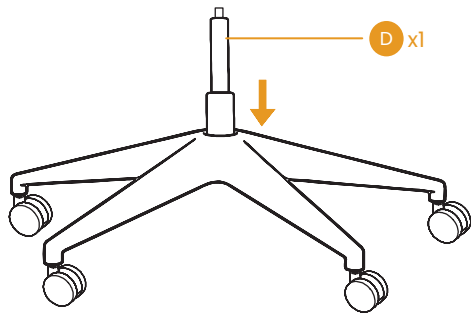

ASSEMBLY INSTRUCTIONS

- STEP 3** Attach the Backrest (A) and Seat Cushion (B) with Bolt (H), align the three holes of the Backrest (A) steel plate with the screw holes of the mechanism at the bottom of the Seat Cushion (B), tighten all the bolts with the Allen Key (G).

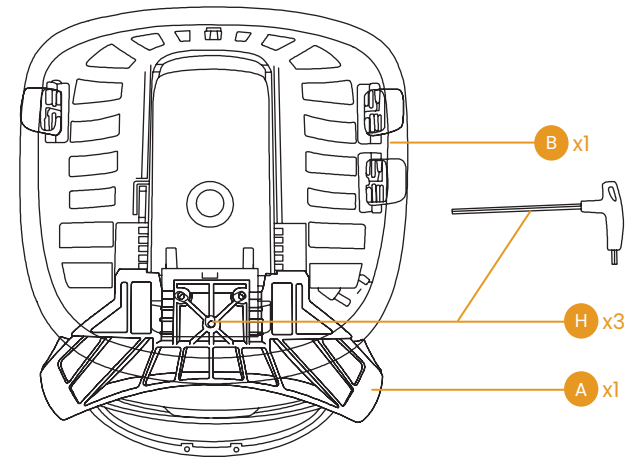

ASSEMBLY INSTRUCTIONS

- STEP 4** Remove Bolts (J) and Bolts (K). Then install the Armrests (C) on both sides and secure it with the previously removed screws. Finally, tighten the Armrests (C) using Allen Key (G).

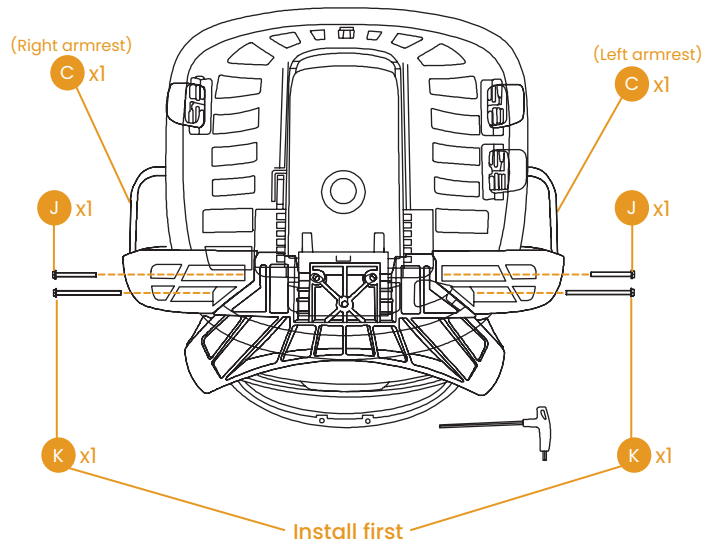

ASSEMBLY INSTRUCTIONS

- STEP 5** Just attach the upper part of the chair to the Gas Lift (D), and your chair is successfully installed.

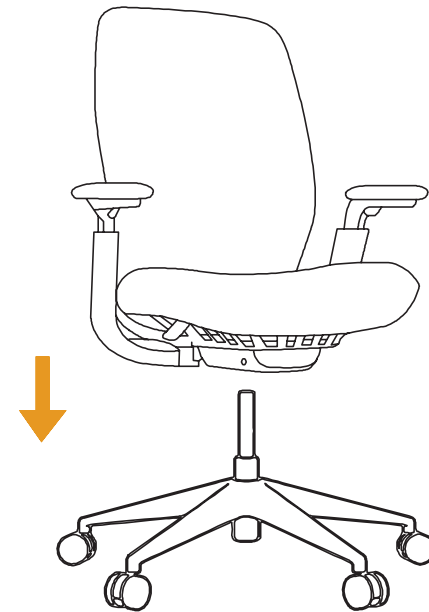

ADJUSTMENT INSTRUCTIONS

**Seat Height Adjustment:**

Paddle-shaped lever on the right front side while seated.

**To raise:**

While taking your weight off the chair, lift the lever up.

**To lower:**

While seated, lift the lever up.

NOTE: Please make sure that your feet rest flat on the floor to get a proper height.

**Seat Depth Adjustment:**

Paddle-shaped lever on the left front side while seated.

**To unlock adjustment:**

While seated, lift the lever up, adjust seat depth by the body.

**To lockdown adjustment:**

While seated, lift the lever down.

NOTE: Please make sure the backrest is at upright position so that you can adjust seat depth by your body.

ADJUSTMENT INSTRUCTIONS

**Tilt Lock Adjustment:****(Four Positions)**

The rear paddle-shaped lever on the left side while seated.

**To Unlock the Backrest:**

Pull the lever upward and apply pressure against the backrest to recline and adjust the angle.

**To Lock the Backrest:**

When the desired recline angle is reached, push the lever downward to lock it in place.

**Armrest-Backrest Linkage:****The armrests and backrest recline synchronously:**

Optimizes viewing distance and arm support while reclining for sustained, focused work.

ADJUSTMENT INSTRUCTIONS

**Armrest Height Adjustment:**

- ❖ **To raise or lower the armrest:**
While seated, press the button to unlock and grasp the base of the arm support to raise or lower them to the desired height.
Release the button to lock the desired height.

4D Adjustable Armrests:

- ❖ **To move armrests forward and backward:**
Grasp the end of the arm pad and slide them forwards or backward.
- ❖ **To slide the armrests left or right:**
While seated, hold the armrest panel with your hand and push it left and right.
- ❖ **To swivel the armrest at a limited angle:**
While seated, hold the armrest panel with your hand and pivot them to the left and right.

ADJUSTMENT INSTRUCTIONS

**Lumbar Support Height Adjustment:**

On the back side of the backrest.

- ❖ **To change lumbar support height:**
While seated, using equal pressure on each end of the lumbar support, raise or lower it to the desired position within the adjustment track.

NOTE: The goal of this function is to find where that lumbar part is most comfortable in support of your back.

LIMITED WARRANTY

COLAMY promises to repair or replace any COLAMY product that is found to be defective in material or workmanship within one year from the date of original purchase, as long as you, the original purchaser, still own it. This is your sole and exclusive remedy under this warranty, subject to the provisions outlined below.

EXCLUSIONS

This warranty does not apply to, and no other warranty applies to:

- Normal wear and tear, which is to be expected over the course of ownership.
- Misuse, abuse, or excessive use of the product.
- Modifications or attachments to the product that are not approved by COLAMY.
- Products that were not installed, used, or maintained in accordance with the product instructions and warnings.
- Products used for rental purposes or unauthorized retail activities.

Product Usage: Normal use for the product is defined as equivalent to a single shift, forty-hour (40) workweek. If the product is used in a manner exceeding this, the applicable warranty period will be proportionately reduced.

RETURN POLICY

We offer a 30-day return policy, meaning that all products purchased through this website may be returned to us within that timeframe. You must contact us within 30 days of receiving the product(s), and they must be returned to us without any undue delays.

CONDITIONS:

- Returned products must be in the same condition as received and returned in their original packaging.

LIMITED WARRANTY

- If the product is not faulty (i.e., if you change your mind or are unhappy with the product for another reason), you are responsible for the cost of return shipping. You must ensure the package arrives safely to us, so we recommend using a courier service that offers tracking.
- If the product is faulty when received, please contact us, and we will assist you with the return, covering the shipping costs in this case.
- We reserve the right to offer partial refunds for returned products that are not in unused condition, are damaged, or have missing parts not due to our error.

HOW RETURNS WORK

To request a return, please fill out the contact form on our website and attach a copy of your invoice as proof of purchase, along with the reason for the return.

We will provide the return address for the product as soon as possible. Once the returned product is received and inspected, we will provide a specific resolution.

If the return is approved, the refund amount will be automatically credited to your original payment method.



You  | ASSEMBLY VIDEO

colamyhome.com
support@colamyhome.com
+1(888) 886-1743